

Portable Evaporative Air Cooler
User Manual
Read and save these instructions before use

Product video:

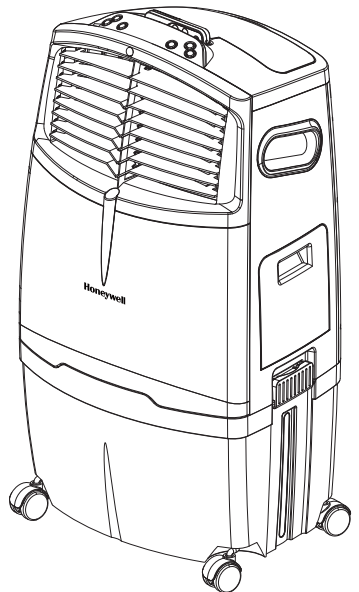

www.honeywellaircoolers.com/products/CL30XC



www.jmatek.com
E-mail: usinfo@jmatek.com

**Model:
CL30XC**

PARTS DESCRIPTION

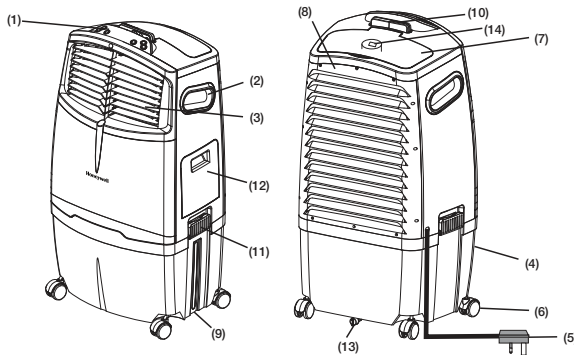

- | | | |
|----------------------|--------------------------|---------------------------------|
| 1) Control Panel | 6) Casters | 11) Detachable Water Tank Latch |
| 2) Handle | 7) Ice Compartment Lid | 12) Water Fill Door |
| 3) Louvers | 8) Rear Grill | 13) Drain Plug |
| 4) Water Tank | 9) Water Level Indicator | 14) Water Regulator |
| 5) Power Cord & Plug | 10) Remote Control | |

WARNING -- READ AND SAVE THE AIR COOLER SAFETY & MAINTENANCE GUIDE AND USER MANUAL BEFORE USING THIS PRODUCT. FAILURE TO FOLLOW THESE INSTRUCTIONS MAY DAMAGE AND/ OR IMPAIR ITS OPERATION AND VOID THE WARRANTY. IN CASE THERE IS ANY INCONSISTENCY OR CONFLICT BETWEEN THE ENGLISH VERSION AND ANY OTHER LANGUAGE VERSION OF THE CONTENT OF THIS MATERIAL, THE ENGLISH VERSION SHALL PREVAIL.

USE & OPERATION

CONTROL PANEL



Icons on Display Screen

- | | | | |
|--|-------------------------|--|------------|
| | Low water level in tank | | High speed |
| | Cool | | Swing |
| | Fan speed | | Timer |
| | Low speed | | Sleep |
| | Medium speed | | |

FUNCTION BUTTONS

POWER

Press the button to turn the unit on. The cooler will start automatically at medium speed. After a few seconds the speed will switch to low. To turn the unit off, press the button again.

SPEED

Press the SPEED button repeatedly to change the speed between High - Medium - Low. The indicator light will show the selected speed:



COOL

Press the COOL button until is illuminated on the display screen. This activates evaporative cooling. The water pump will operate and you will feel the cooler air after the Honeycomb Cooling Media is completely wet. When the is not illuminated on the display screen, the unit switches to a fan only mode, without evaporative cooling.

WARNING: Please ensure sufficient water is in the water tank otherwise you may hear a Low Water Alarm and the cooler will start in a Fan only mode without evaporative cooling.

USE & OPERATION (CONTINUED)

FUNCTION BUTTONS (CONTINUED)

TIMER

Press the TIMER button until the desired time duration setting is selected. When the set time has passed, the unit will automatically turn off (unit remains in Standby mode until power cord is unplugged from electrical socket). The TIMER function allows you to program the unit for up to 8 hours of use.

SWING

Press the SWING button until  is illuminated on the display screen.

The louvers will begin to move left to right automatically.

Vertical Air Flow - You can manually adjust the louvers to change vertical air flow.

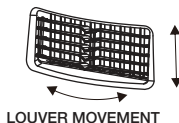

SLEEP

Press the SLEEP button until  is illuminated on the display screen. When the SLEEP mode is selected, the fan will run on High for one hour, then Medium for the second hour and on Low speed from the third hour onwards until you switch off the unit.

ROOM COOLING AND HUMIDIFYING

In cooling mode, Honeywell Air Coolers provide cool, moist air through the evaporation of water. There is a manual Water Regulator knob located in the ice compartment of the unit. This allows you to adjust the amount of water pumped over the Honeycomb Cooling Media, thus helping to control cooling and humidification levels.

When the Water Regulator is set to MIN, the water pump distributes a minimal amount of water to the Honeycomb Cooling Media. This results in less water evaporation and reduces the cooling effect.

When the Water Regulator is set to MAX, the water pump distributes the maximum amount of water to the Honeycomb Cooling Media. This results in maximum water evaporation and greater cooling performance.

Water Regulator



REMOTE CONTROL



POWER : ON / OFF

SPEED : Low / Medium / High

COOL : Evaporative Cooling On/Off

SWING : Controls the motion of the louvers

TIMER : Controls the Timer function for automatic off

SLEEP : Turns on Sleep mode

Note:

- The remote control requires AAA (2 x 1.5V) batteries for replacement.
- Open the battery compartment at the back of the remote control and insert the batteries inside. Care must be taken to insert the batteries according to the correct polarity (+ / -) markings shown inside the battery compartment.
- Always point the remote control signal transmitter towards the unit when operating. Make sure that the signal path is not obstructed.
- Remove the batteries if the unit is not going to be used for an extended period of time.
- Do not drop the remote control.
- Do not mix different types of batteries such as alkaline, carbon-zinc, or rechargeable batteries.
- Do not mix old and new batteries.
- Do not recharge the battery.
- Exhausted batteries are to be removed from the product and safely disposed of as per local regulations.
- Do not dispose of batteries in fire. Batteries may explode or leak.

WARNING: Caution for ingestion of the small battery. Keep away from children and animals.

USE & OPERATION (CONTINUED)

COOLER LOCATION

Make sure to position the air cooler correctly before you set up and start using the product. Please refer to the COOLER LOCATION section of the separate Safety & Maintenance Guide.

FILLING WITH WATER

CAUTION:

Unplug the unit from the electrical power outlet before emptying or refilling the water tank.

Open the Water Fill Door located on the side of the unit.

The Water Level Indicator is located at the side of the unit. Refill the water tank when water level is low. Do not fill water above the "Max." water level mark to avoid water droplets collecting on the louvers. Check the water level in the tank before running the COOL function. Make sure that the water in the tank is above the minimum water level mark. Running the unit in COOL mode with inadequate water may cause pump failure.

Note: The water capacity refers to the total volume of water that can be contained within the air cooler water tank and water distribution system. The water capacity in the tank at the "Max." indicator level may be lower than the actual water capacity of the air cooler.

Note: If ice is available, you may add ice in the top ice compartment to enhance the cooling performance.

WARNING: Do not fill water tank with dirty water or salt water. This can damage the unit and Honeycomb media.

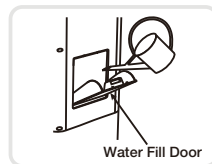

LOW WATER ALARM

The unit is equipped with a low water sensor. In Cooling Mode, when water in the tank is below the minimum level, you will hear a beeping sound and the  will flash continuously. The unit will automatically pause evaporative cooling.

Refill the water tank to deactivate the alarm in cooling mode. First switch OFF the unit and unplug from the power outlet. Fill the water tank with water above the minimum water level mark. Plug in and switch ON again.

To deactivate the alarm and continue using the unit as a fan (without evaporative cooling), switch the unit OFF and then ON again. The Low Water Alarm will not activate in Fan only mode. The Low Water Alarm will sound again if the COOL function is activated while the water tank is still empty.

CLEANING & DRAINING THE WATER TANK

If the cooler will not be used for a long period of time, please refer to the STORAGE & MAINTENANCE GUIDELINES located in the separate Safety & Maintenance Guide.

WARNING:

Before cleaning the unit, switch the unit OFF and disconnect from the power outlet.

- Move the unit to a location where the water can be drained. Remove the cap from the Drain plug located at the bottom of the unit. Allow the tank to empty.
- Detach the water tank by unlocking the Detachable Water Tank Latches on both sides of the unit. Lift the cooler upwards away from the base and place it carefully and vertically on the floor. Be careful not to bend the water pump tubes and other parts that will hang from the bottom of the unit when the body is removed from the tank.
- Refill the water tank with clean water and drain it completely. Clean the water tank with dish detergent or a damp cloth and rinse it thoroughly.

CLEANING & DRAINING THE WATER TANK (CONTINUED)

- Refill the water tank with clean water, up to the maximum level.
- Replace the top of the air cooler carefully back onto the tank and lock the side latches. The air cooler is now ready to be used.
- Use a damp cloth to remove dirt and dust from the surface of the unit. Never use corrosive elements or chemicals to clean this product.
- When the product is not in use, store the unit in a dry place out of direct sunlight.

CLEANING THE CARBON DUST FILTER* AND HONEYCOMB COOLING MEDIA

- The appliance is supplied with a Carbon Dust Filter* & Honeycomb Cooling Media.
- The Carbon Dust Filter* and Honeycomb Cooling Media are located inside the Rear Grill. See Figure 1 for instructions on how to remove them from the unit for cleaning and maintenance.
- Do not run the unit in COOL mode with stale water in the tank. You must empty the water tank and refill with fresh water, especially if the tank has not been cleaned in a long time.
- The cleaning frequency for the Honeycomb media depends on local air and water conditions. In areas where the mineral content of water is high, mineral deposits may build up on the Honeycomb Cooling Media and restrict air flow. Draining the water tank and refilling with fresh water at least once a week will help reduce mineral deposits. If mineral deposits remain on the Honeycomb Cooling Media, the media should be removed and washed under fresh water. The media should be cleaned every two months or sooner, depending on your needs.
- For best results allow the Honeycomb Cooling Media to dry after each use by turning off the cool function 15 minutes before turning the unit off.

Figure 1:

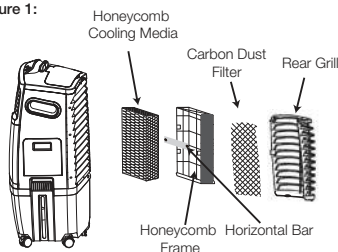

Removing the Carbon Dust Filter/ Honeycomb Cooling Media:

1. Remove all the screws from the Rear Grill of the Air Cooler.
2. Carefully pull out the rear grill from the cooler.
3. Slide out the Carbon Dust Filter* and clean with water.
4. The Honeycomb Cooling Media is secured on the Honeycomb Frame by a Horizontal Bar that is fixed in place by two screws. Remove these two screws to release the Horizontal Bar and slide the Honeycomb out of the frame.
5. Replace or clean media with water and a damp cloth as needed.

WARNING: DO NOT operate the Air Cooler when the Rear Grill or Honeycomb Frame is removed from the Air Cooler, or if there is a loose-fitting Rear Grill or Honeycomb Frame. Doing so can cause serious injury or dangerous electrical shock.

*Applicable for models with Carbon Dust Filter only.

TECHNICAL SPECIFICATIONS

| | |
|-------------------|---|
| Model | CL30XC |
| Voltage | 110 - 120V |
| Frequency | 60Hz |
| Ampere | 2.4A |
| Wattage | 288 W |
| Cooling Media | Honeycomb |
| Product Dimension | 458 (W) x 352 (D) x 856 (H) mm 18.0 (W) x 13.8 (D) x 33.7 (H) in |
| Net Weight | 11.3 kg / 24.9 lbs |

ELECTRICAL WIRING DIAGRAM

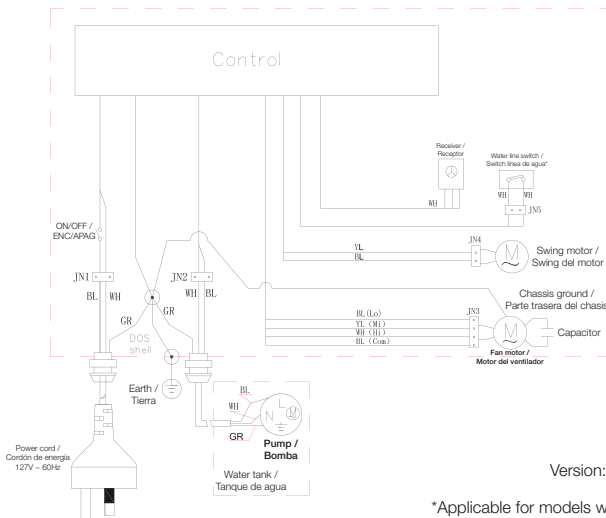

JMATEK North America LLC
Mahwah, New Jersey 07495 USA
Phone: 1-800-474-2147
Email: usinfo@jmatek.com
Web: www.jmatek.com

© 2016 JMATEK Limited. All rights reserved.
The Honeywell Trademark is used under license from
Honeywell International Inc.
Honeywell International Inc. makes no representations
or warranties with respect to these products.
This product is manufactured by Alitek Int'l Corp. Ltd.
(subsidiary of JMATEK Ltd.)

Honeywell